

Tesrol<sup>®</sup>  
Est.1981

# Doors and Decorative Board





## Table of Contents

P.3	ABOUT TESROL
P.5	ONLINE VISUALISER
P.7	VACUUM FORMED DOORS
P.9	POLYURETHANE - PAINTED DOORS VACUUM FORMED AND PAINTED DOOR DESIGNS VACUUM FORMED AND PAINTED COLOURS
P.43	DECORATIVE BOARD SUPERCLEAN LIKEWOOD 2D+ BEVELLED EDGE DOORS
P.54	CREATIVE IDEAS AND ACCESSORIES
P.62	SOCIAL LINKS





Tesrol was founded by a father and his son in 1981, crafting made-to-measure solid timber cabinet doors out of a small factory unit in Girraween, Sydney. Tesrol's focus on its products was to uphold a standard that went well beyond their client's expectations. The craftsmanship set by Tesrol achieved new benchmarks within the industry, earning Tesrol a reputation for the highest-quality products.

Tesrol's high-quality was so well received that the company quickly expanded beyond solid timber doors and began offering a comprehensive range of products. With Tesrol's combination of quality products and product range, the business became an unprecedented success, and rapid expansion soon spread across Australia's east coast. Tesrol remain an Australian family-owned and manufacturing company to this day. Tesrol continue to be innovative market leaders, constantly improving thanks to the efforts of every one of its team members.

Over forty years later and Tesrol is still one of Australia's major cabinet door manufacturers and has further expanded into the decorative board market. The company's main facility is a state-of-the-art manufacturing operation in Wetherill Park, NSW, covering over 8000 square metres and housing several major divisions and machinery lines. Today, Tesrol offers a comprehensive range of cabinet doors and decorative board products such as Likewood 2D+, Superclean: anti-fingerprint, vacuum formed doors, and polyurethane doors. All Tesrol products are available in contemporary finishes across a diverse range of products.

Tesrol is the company of choice for the highest-quality cabinet doors, joinery accessories and decorative board products among the most demanding cabinet makers, architects, and interior designers. Tesrol products are suitable for many interior applications, including kitchens, bathroom vanities, wardrobes, office spaces, and commercial fit-outs. We service Australia with distribution centres in Sydney, Melbourne, and Brisbane.

For further information on any of our products, please get in touch with Tesrol to see how we can assist you with your selection of products for a new kitchen renovation or joinery project.

Presenting our

# Online Visualiser.

## **Dream. Visualise. Create.**

Tesrol's Online Visualiser is a way for you to select from a range of pre-designed kitchen, laundry and wardrobe layouts, and configure these to your liking. Choose from an extensive range of colours and products to help conceptualise the exact look you are seeking for your new kitchen.

Change the colour combinations of the doors, panels, benchtops, and more, to show how our range of products can complement each another. Showcase a two-tone effect, or just a single colour, and also find a matching benchtop and splashback.

The Online Visualiser is compatible with a range of devices including your computer, smartphone, and tablet.

Visit [www.tesrol.com.au/visualiser](http://www.tesrol.com.au/visualiser) or scan the QR code below on your smartphone.







Design: 100-35  
Colour: Gloss White  
Product: Vacuum Formed





## Vacuumformed doors and panels

Our range of vacuum formed doors offer you a wide selection of modern designs, colours, and edge profiles.

Doors are available with a face routed design or plain, along with a range of edge profiles and colours, giving you varied options for your new kitchen project.

Tesrol is renowned throughout the industry for its high standard, quality vacuum formed doors.

At Tesrol we have been producing high quality vacuum formed doors for over two decades. With this comes integrity, knowledge, and experience in all of our manufacturing processes of vacuum formed doors.

Our doors are produced with technologically advanced machinery from Germany and we only use the highest grade materials to ensure the finished product reflects our brand values.

If it's a vacuum formed door for your kitchen, make sure it is Tesrol, the brand you can trust and backed by our seven-year warranty.

# Polyurethane doors and panels

Tesrol's range of 2-pack polyurethane painted doors give you limitless colour options in a wide range of designs and edge profiles, to define any style of kitchen, whether it is modern, sleek, contemporary or provincial.

Tesrol's 2-pack polyurethane painted doors are available in a wide range of finishes depending on your individual taste from; 10% Matt, 30% Satin, 60% Semi-Gloss and 90% High-Gloss. We also have the capacity to indicatively colour match most of the Australian paint colours from their paint codes.

At Tesrol we are committed to our quality, brand and reputation. We purposely built our own modern in-house paint facility utilising the latest machinery and technology with fully trained and qualified staff to meet our high standards.

This enables us to achieve the highest quality and ensures a premium standard of finishing to our polyurethane doors, which, we consider to be well above the industry standard.





Design: 100-3S  
Colour: Tesrol White 90% High-Gloss  
Product: Polyurethane

Design: 100-3S  
Colour: Matt Elegant White  
Product: Vacuum Formed



## Modernline 100 Series



DESIGN 100 - EP2



DESIGN 100 - EP4



DESIGN 100 - EP3



DESIGN 100 - EP3S



DESIGN 100 - EP5



DESIGN 100 - EP6

# Modernline 100 Series



DESIGN 100 - EP15



DESIGN 100 - EP16



DESIGN 100 - EP17



DESIGN 100 - EP19

Design: 100-35  
Colour: Matt White  
Product: Vacuum Formed



Design: 233-35  
Product: Polyurethane  
Colour: Mixed Colours

## Traditional 200 Series



DESIGN 200 - EP3



DESIGN 234 - EP3S

Not available in vacuum formed  
Minimum 21mm thickness





DESIGN 212 - EP3S | 60mm Approx. |



DESIGN 233 - EP3S  
Not available in vacuum formed



DESIGN 255 - EP3S



DESIGN 256B - EP3S  
Minimum 21mm thickness

# Traditional 200 Series

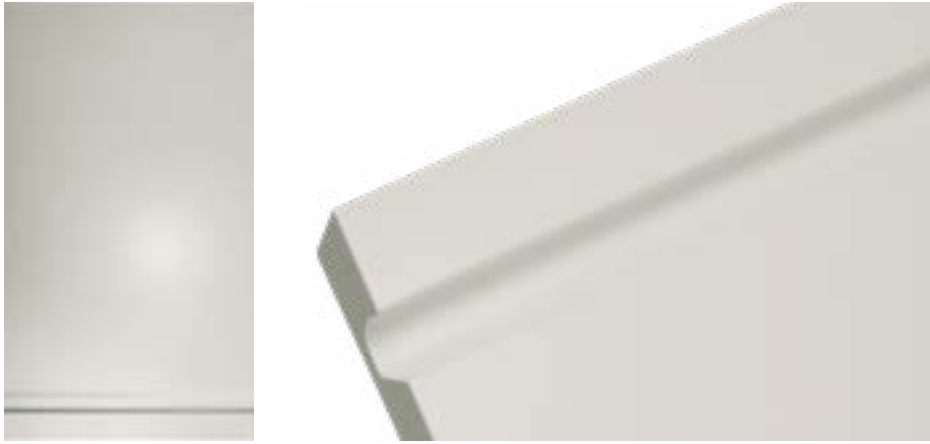

**DESIGN 256T - EP3S**  
Minimum 21mm thickness



**DESIGN 258 - EP3S**  
Not available in vacuum formed



**DESIGN 275 - EP3S**



**DESIGN 276 - EP3S** | 60mm Approx. |

Design: 233-35  
Colour: Dulux Antique White  
USA 90% High-Gloss  
Product: Polyurethane





Design: 412-17  
Colour: Matt White  
Product: Vacuum Formed

## Elegance 400 Series



Vacuum  Painted

DESIGN 400 - EP2



DESIGN 416 - EP3



Vacuum  Painted

DESIGN 404 - EP3S

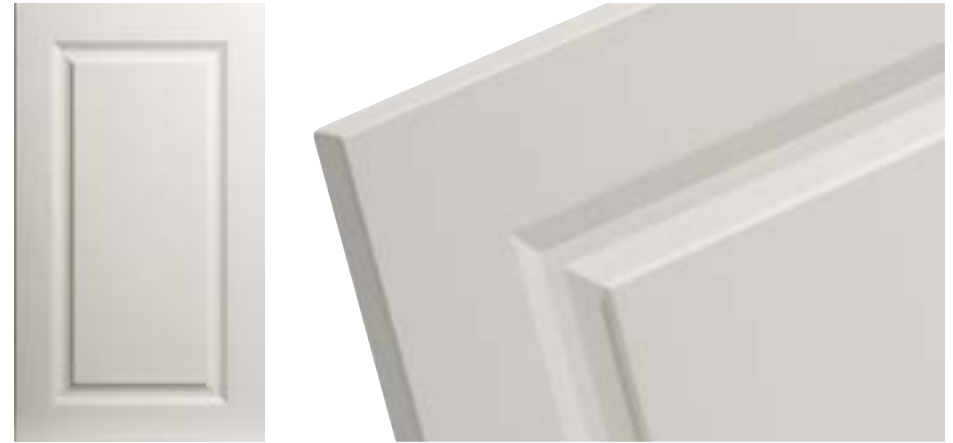

DESIGN 412 - EP3S



DESIGN 418 - EP3S



DESIGN 422 - EP2

# Elegance 400 Series



Vacuum Painted

DESIGN 430 - EP3S



Vacuum Painted

DESIGN 438 - EP3

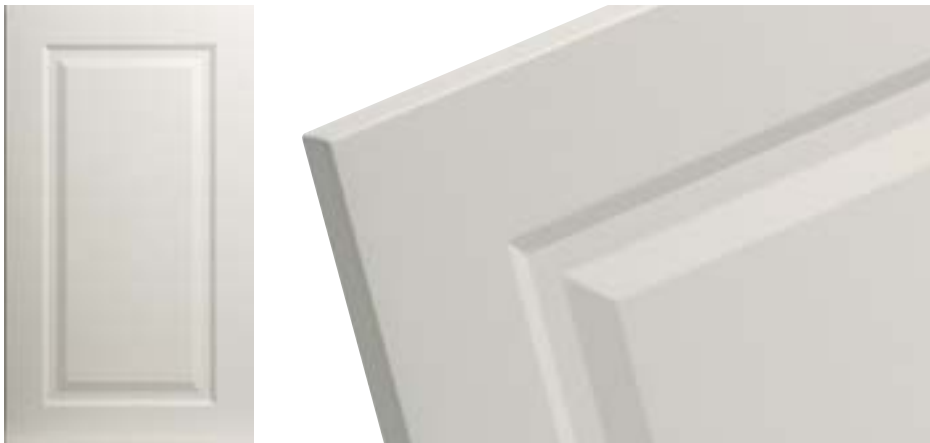

DESIGN 455 - EP3S



DESIGN 484 - EP3



Design: Mixed Designs - 438 and 601 SP  
Colour: Alabaster 30% Satin  
Product: Polyurethane

# Contemporary 500 Series

Not available in 'gloss' vacuum formed



Design: 560-EP3S  
Colour: Dulux Miller Mood 30% Satin  
Product: Polyurethane



DESIGN 502 - EP3S



DESIGN 510 - EP3S





**DESIGN 504 - EP3S**



**DESIGN 506 - EP3S**



**DESIGN 520 - EP3**  
Not available in vacuum formed



**DESIGN 560 - EP3**  
Not available in vacuum formed

# Contemporary 500 Series

Not available in 'gloss' vacuum formed

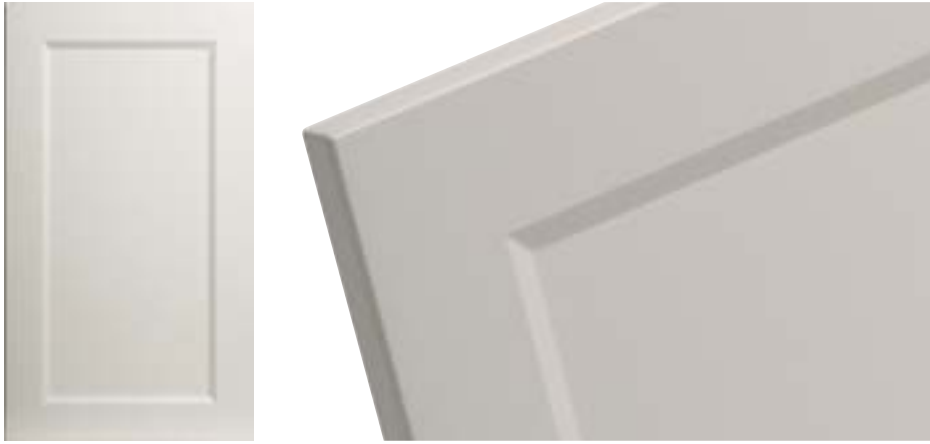

DESIGN 570 - EP3S



DESIGN 575 - EP2



DESIGN 576 - EP2

60mm Approx.



DESIGN 593 - EP3



Design: 560-EP3S  
Colour (Top): Dulux White 30% Satin  
Colour (Bottom): Sea Paint 30% Satin  
Product: Polyurethane

# Heritage 600 Series

Not available in 'gloss' vacuum formed. Doors are made from min. 21mm substrate.

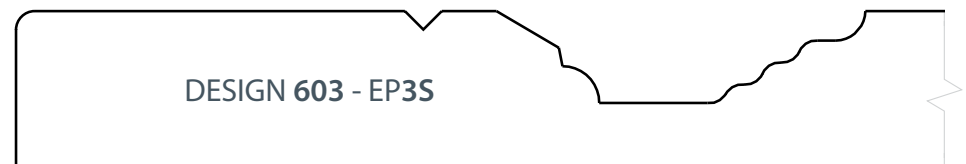



DESIGN 601 - EP2



DESIGN 602 - EP3S  
60mm Approx.



DESIGN 604 - EP2



DESIGN 605 - EP2  
60mm Approx.

# Heritage 600 Series

Not available in 'gloss' vacuum formed. Doors are made from min. 21mm substrate.



DESIGN 606 - EP3



DESIGN 623 - EP3S



DESIGN 631 - EP3S



DESIGN 634 - EP3S  
Not available in vacuum formed



Design: 606-3 (V-groove special as 609)  
Colour: Tesrol White 30% Satin  
Product: Polyurethane

# Vacuum Formed Colours

At Tesrol, we have a vast range of Vacuum Formed colours to suit your next kitchen, cabinetry, or commercial design project. From a generous amount of white hues to woodgrains, textured colours, and more. Our colour range can add excitement, class, and elegance to your project.

If you are looking for a sharper more innovative finish, try combining two colours into your project through the use of different coloured doors and cabinets to give your project a real 2-tone effect and add both harmony and contrast.

## Order Samples Online

Scan the QR code to be taken to our website to order samples directly to your front door or business.





## Matt Zero

---

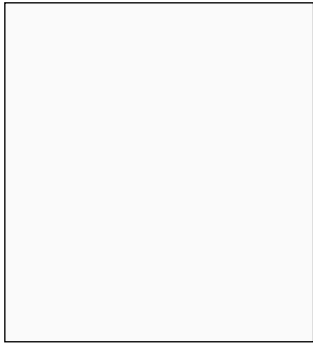

Frosty White

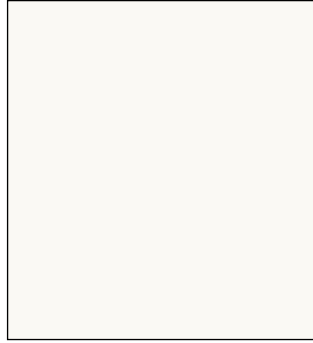

Smooth White

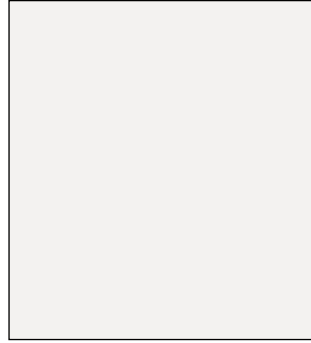

Off White



Light Grey



Night Sky



Blue Grey



Dark Grey



Black

Note: Due to the nature of the printing process, the colours and images depicted throughout this brochure may vary compared to the actual products' colour and results achieved. Images and colours are to be used as a guide only.

## Suedette

---

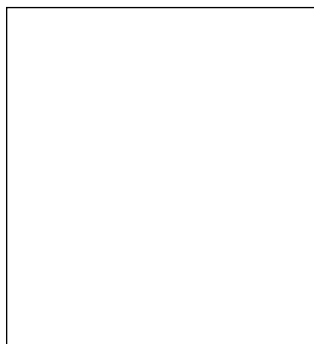

Premium White

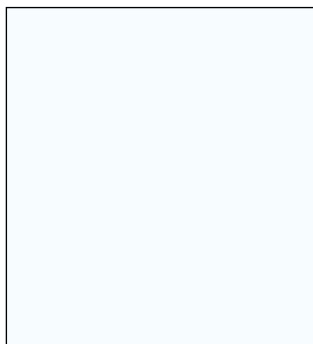

Alpine White

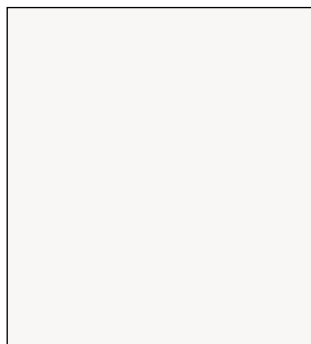

Ceramic White

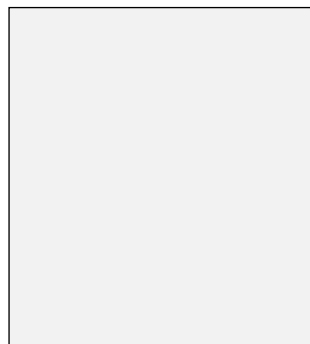

White Grey

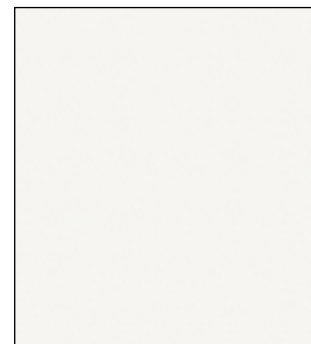

Platinum White



Pearl Grey



Indigo Blue

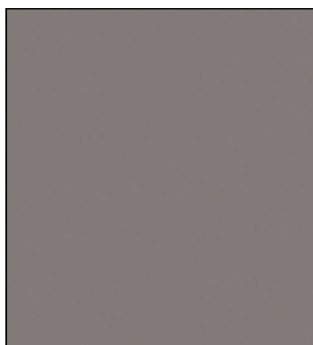

Dust Grey

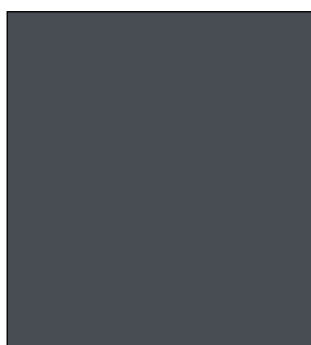

Graphite

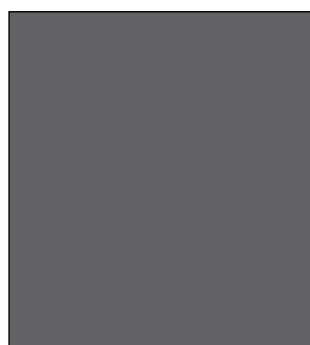

Onyx Grey

## Texture

---

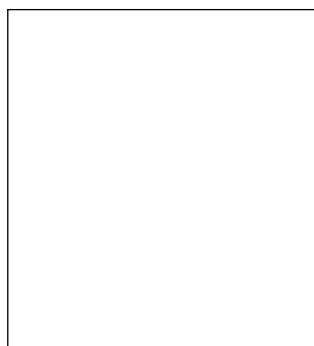

Designer White

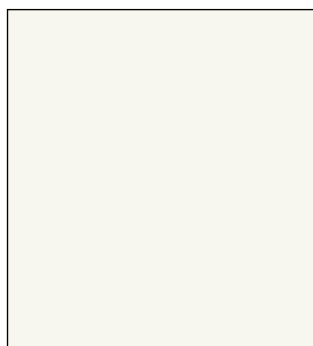

Classic White

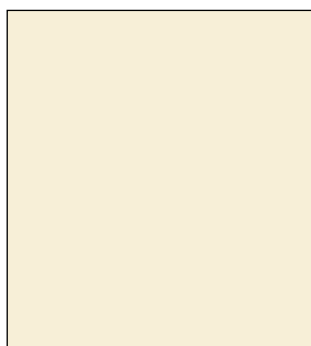

New Antique White

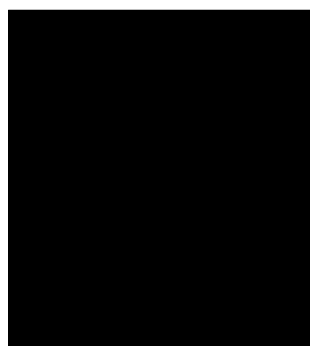

Black

Note: Due to the nature of the printing process, the colours and images depicted throughout this brochure may vary compared to the actual products' colour and results achieved. Images and colours are to be used as a guide only.

# Printed

---



Hacienda White



Spring Oak



Tisano Wood

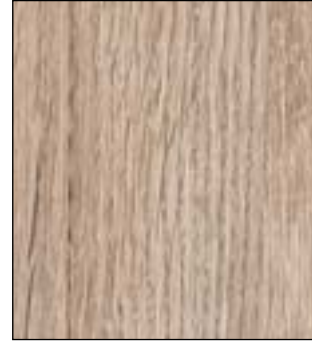

Montana Oak



Clermont Oak



Smoked Teak



Winter Oak



Marone Hickory



Fresco Arizona



Fresco Nevada



Fresco Colorado



Pinnie Latte

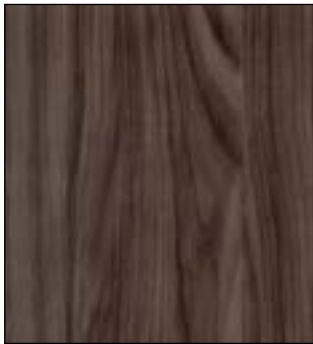

Fruitwood

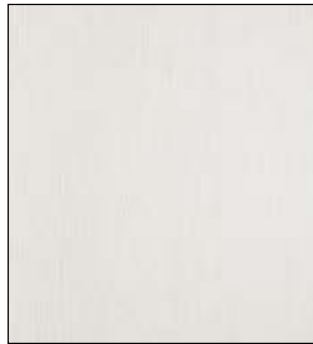

White Rough Oak



Graphite Rough Oak

Note: Due to the nature of the printing process, the colours and images depicted throughout this brochure may vary compared to the actual products' colour and results achieved. Images and colours are to be used as a guide only.

# Matt

---

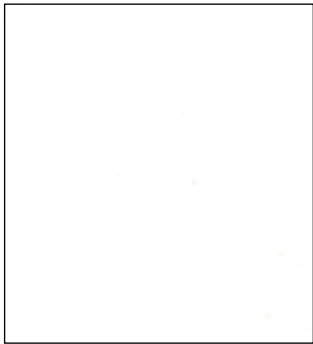

Elegant White

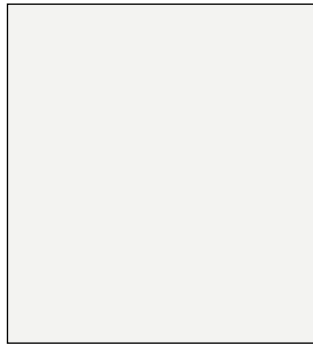

Brilliant White

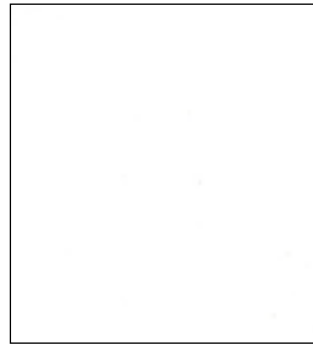

White

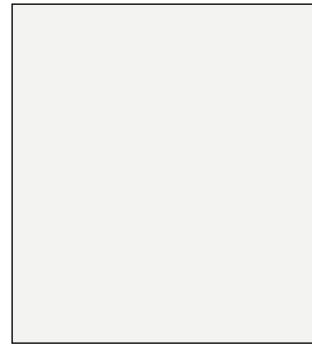

Classic White

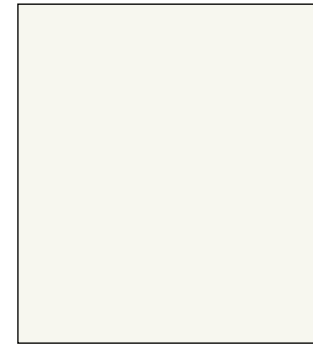

LX White

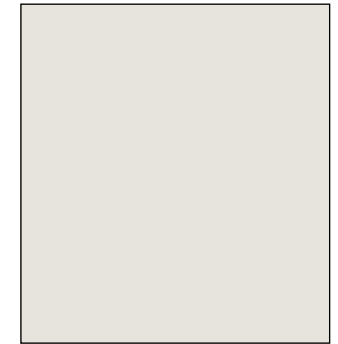

Alabaster TMF

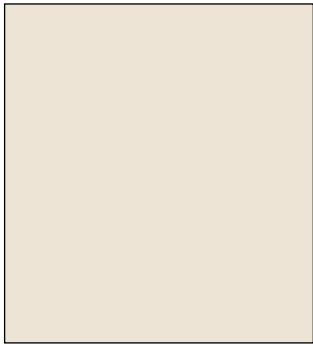

Vintage White

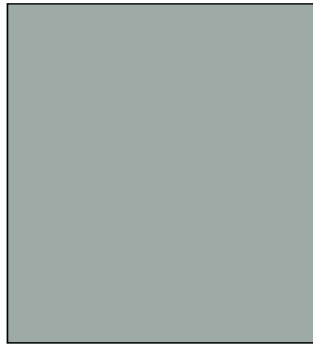

Spruce

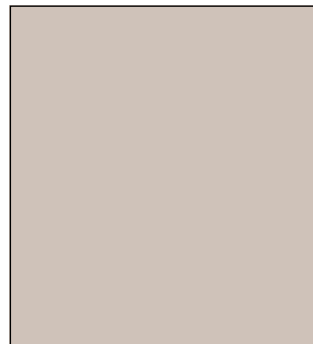

Light Sand

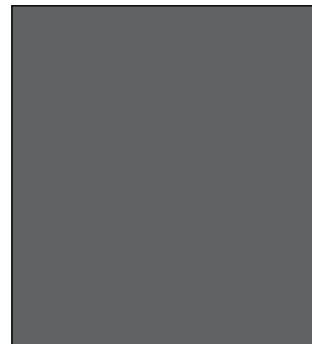

Cloud Grey

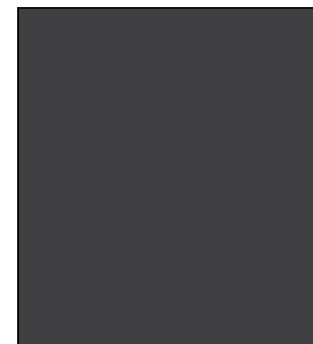

Blue Stone



Ink

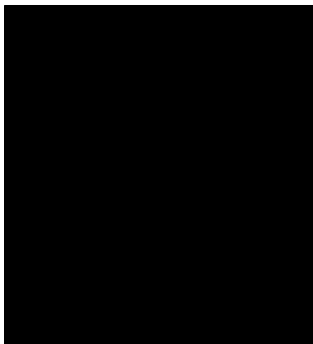

Black

Note: Due to the nature of the printing process, the colours and images depicted throughout this brochure may vary compared to the actual products' colour and results achieved. Images and colours are to be used as a guide only.

# Supermatt

---

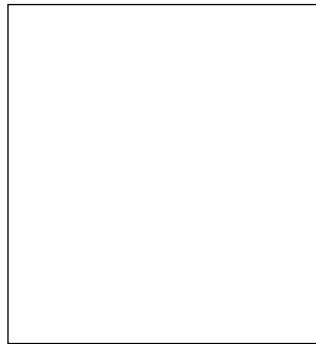

White

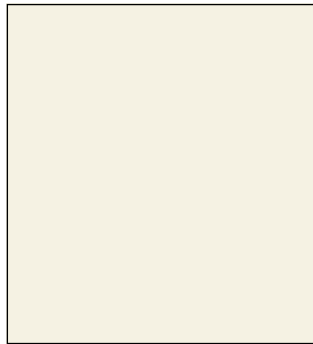

New Fair Bianca

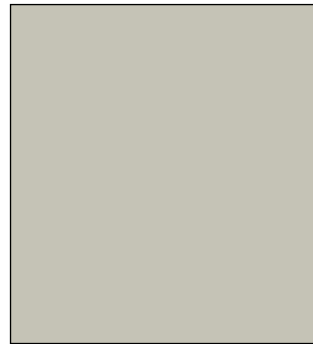

Mushroom



Clay

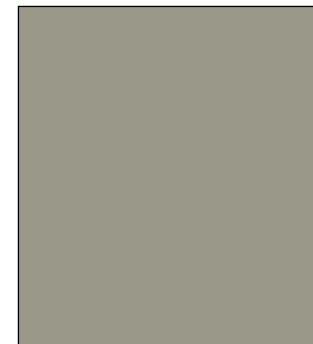

Dakar

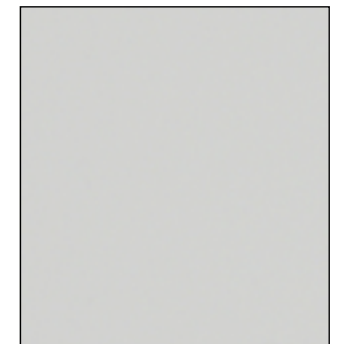

White Grey

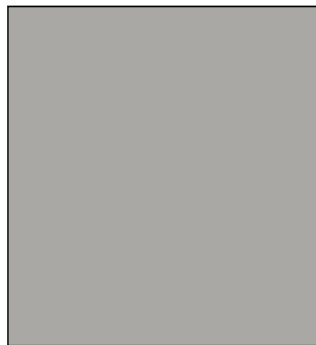

Warm Grey

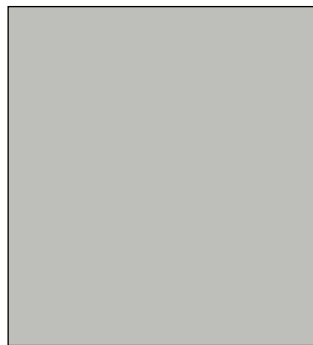

Pearl Grey

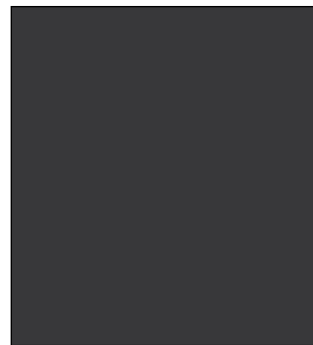

Steel Grey

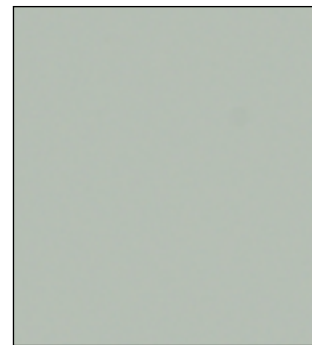

Celadon

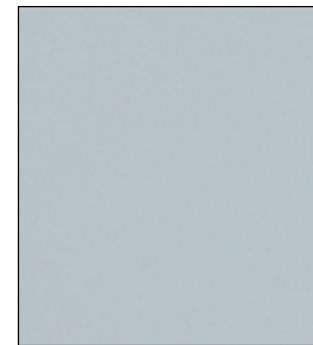

Green Blue



Bayleaf

Note: Due to the nature of the printing process, the colours and images depicted throughout this brochure may vary compared to the actual products' colour and results achieved. Images and colours are to be used as a guide only.

# Gloss

---

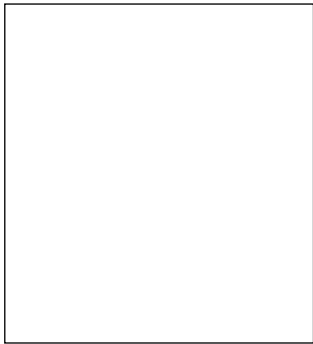

White

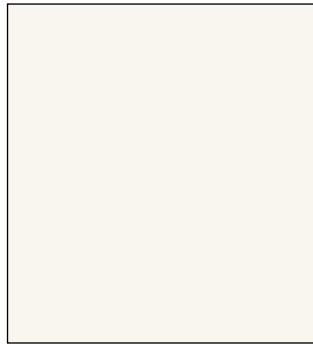

Classic White

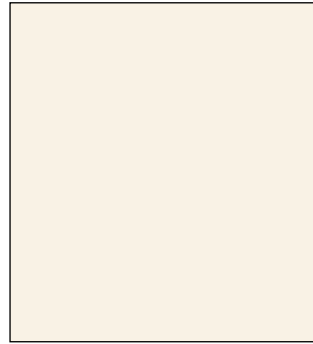

Parchment

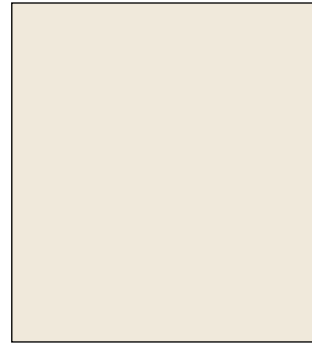

Alabaster

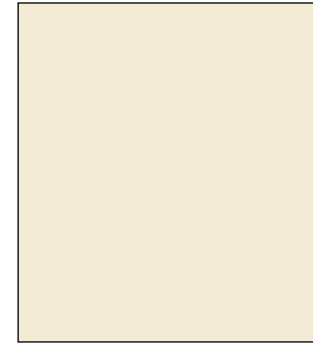

New Antique White

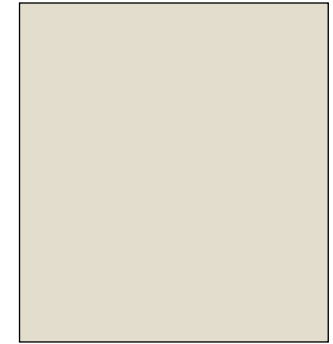

Royal Oyster



Light Sand

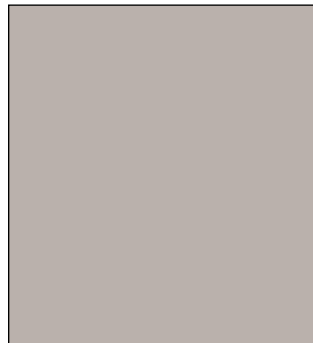

Powder Grey

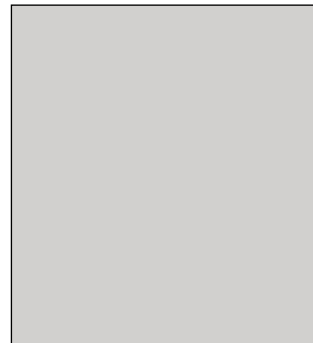

Cashmere

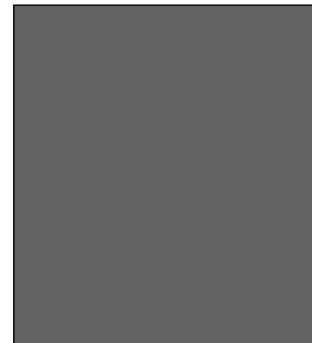

Cloud Grey

Note: Due to the nature of the printing process, the colours and images depicted throughout this brochure may vary compared to the actual products' colour and results achieved. Images and colours are to be used as a guide only.





Design: Custom Design  
Colour: Sandy Day 30% Satin  
Product: Polyurethane



# Polyurethane Finishes

Tesrol door designs are also available in a polyurethane finish. This allows a far greater choice of both colour and design. Tesrol can match most popular brand colours by name. Painted doors are available in 10% Matt, 30% Satin, 60% Semi-Gloss and 90% High-Gloss finishes in 2-pack polyurethane.

## Painted Finishes Available

---

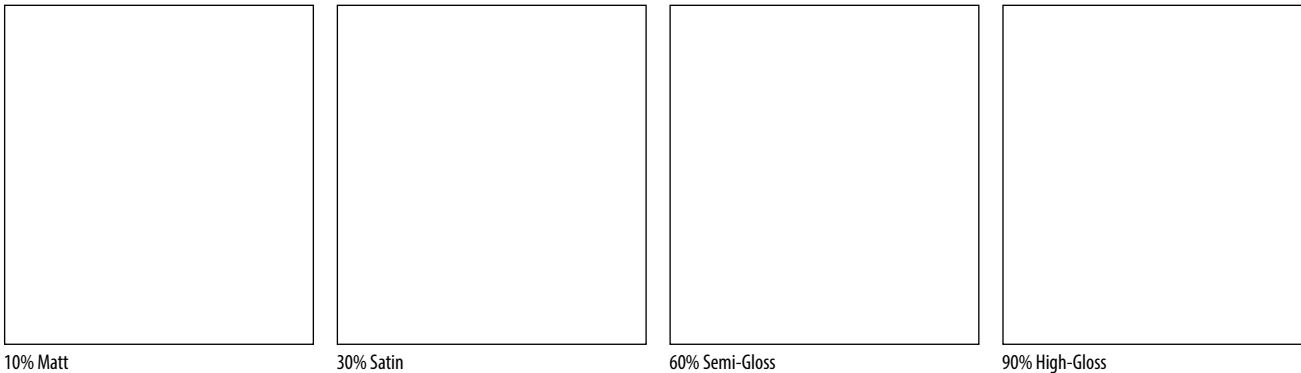

NOTE: No responsibility is accepted for products supplied by Tesrol which do not match other pre-painted finishes.





Design: 600-3S  
Colour: Taubman's Winter Ice - Satin  
Product: Polyurethane



Design: 634-35  
Colour: Taubman's Winter Ice - Satin  
Product: Polyurethane



Design: Cut and Edge  
Colour: SC Carbon  
Product: Superclean



# Decorative Board.

Tesrol manufacture in Australia, a wide range of Decorative Board Products available in either sheet form or doors and panels that are cut and edged to size. These products are the latest surface finishes and are used globally.

## ***Superclean: Anti-Fingerprint***

The latest breakthrough in revolutionary surface technology - available in a stunning supermatt finish.

## ***Likewood 2D+***

Likewood 2D+ is available in an array of exciting prints in timber finishes reflecting the appearance, feel and touch of real timber.



Design: Cut and Edge  
Colour: SC Carbon  
Product: Superclean

# Superclean

Introducing Superclean: Anti-fingerprint, the latest breakthrough in revolutionary surface technology - available in a stunning supermatt finish. Superclean's unique finish is a flat, low sheen and low reflective surface. This finish helps give it a super smooth silk-like appearance in both touch and feel. This revolutionary new technology comes designed with a unique surface coating that is highly-resistant to fingerprint markings on the surface from your typical day-to-day use.

Superclean is suitable for both horizontal and vertical applications. It can be used to suit a range of cabinetry needs including kitchen benchtops and doors, office furniture and fit-outs, commercial application, hospitals and much more. This is a perfect product solution that has the ability to be used in nearly every joinery project imaginable. Superclean gives you the ability to provide your next project with a look of distinct style and sophistication.

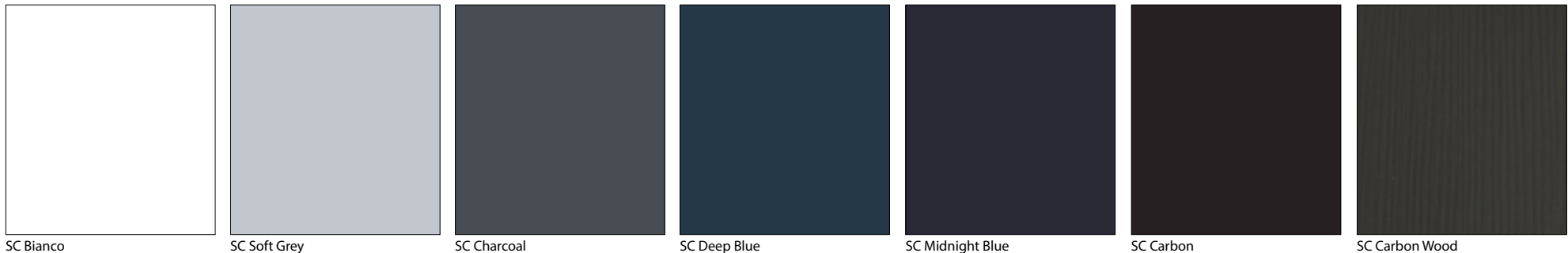

Note: Due to the nature of the printing process, the colours and images depicted throughout this brochure may vary compared to the actual products' colour and results achieved. Images and colours are to be used as a guide only.

# LikeWood 2D+

Likewood 2D+ is the perfect alternative to solid timber & timber veneers giving the appearance, consistency of grain features & uniformity in colour. Likewood 2D+ is an Olefin film containing no PVC with an Electron Beam (EB) clear cured surface. The clear coated EB surface technology enhances the product durability and wearability making it suitable for a wide range of interior applications from kitchen doors, wardrobes, home furniture, commercial shop and office fitouts, internal doors, hotels and acoustic panels giving you a broad array of applications.







Design: Cut and Edge  
Top: Genuine Oak Likewood2D+  
Bottom: Carbon Superclean



Design: Cut and Edge  
Colour: Alpine Oak  
Product: Likewood 2D+



Blonde Ash



Light Oak



Genuine Oak



Lemon Oak



Mountain Ash - *New*



Blackbutt - *New*



Golden Birch

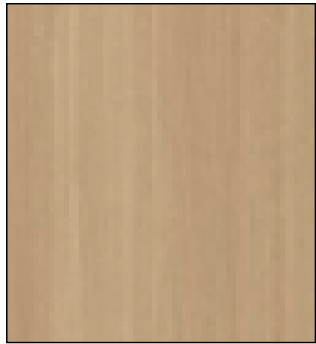

Alpine Oak



Clear Ash



Milano Oak

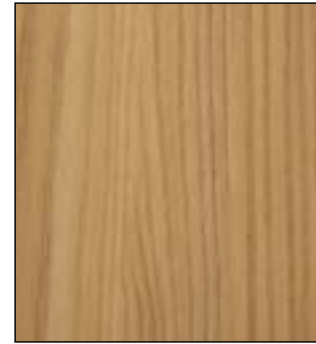

Nordic Ash



Brown Oak



Grey Gum - *New*



Light Walnut



Brown Blackwood - *New*



Spotted Eucalyptus - *New*



Note: Due to the nature of the printing process, the colours and images depicted throughout this brochure may vary compared to the actual products' colour and results achieved. Images and colours are to be used as a guide only.

# Bevelled Edge Doors

Manufactured in Australia, Tesrol offers a comprehensive collection of cut and edged decorative board products in sheet form, doors and panels. The solution to your next interior project is at hand utilising these latest surface finishes.

We also offer the bevelled-edge door finish in our iSuperclean, Likewood2D+, Puregloss and Purematt ranges. This is an exciting and innovative direction that Tesrol has designed to give a streamline, uncluttered look for kitchen, bathroom and cabinetry. Produced to exacting Tesrol standards.



Angled shot of door showing bevelled edge profile.



Rear shot of door showing matching ABS bevelled edging.



Design: Cut And Edge With Bevelled Edge  
Colour: Bronzed Elm  
Product: Likewood 2D+

# Creative Accessories.

Architects and interior designers can create great designs by combining the best materials and colours to suit their client's needs.

At Tesrol our design team is constantly developing new products that allow our customers to achieve stunning results. Great design is all about the clever use of space and light, combined with the best quality materials, colours and textures to suit the particular project.

Cabinet door designs and accessories are now so stylish that they can be used throughout the entire home or office.

Some examples of integrating into other areas include vanities in your bathroom, laundry, panelling, wardrobe doors, and decorative partitions. The result is a look which designers love as it visually blends the various areas of your home.

Tesrol is well known for their ability to produce exciting one off pieces and custom made components to add a touch of flair to any project. Creative accessories can bring your designs to life - giving a unique and artistic flair to your next project.



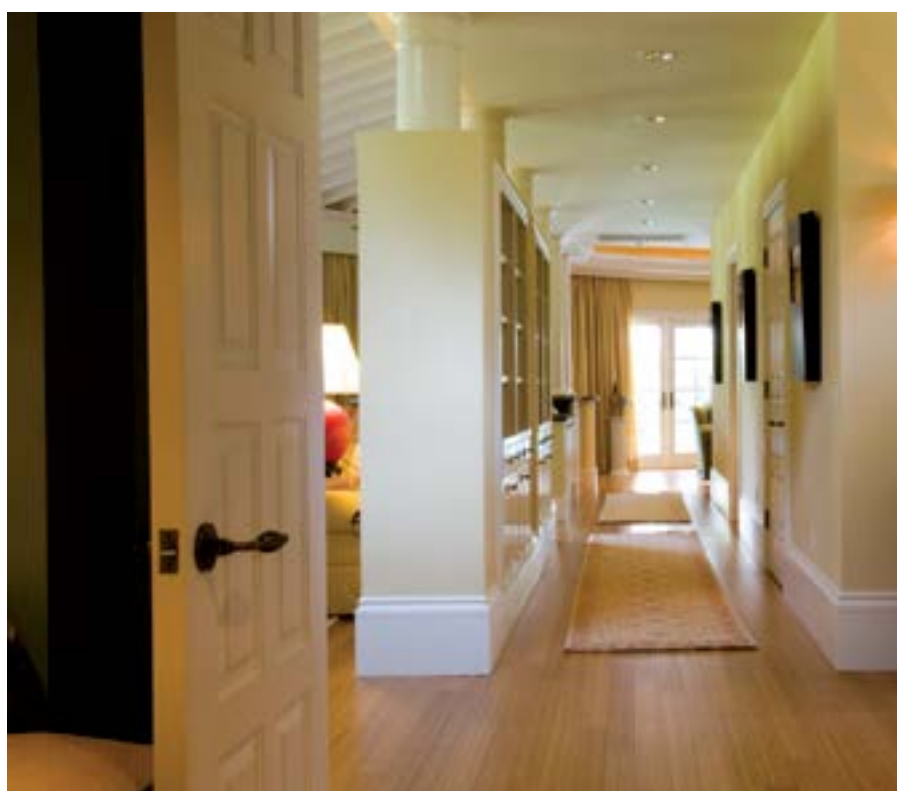

## Recess Rails

---

Current trends in kitchen and cabinetry designs have uncluttered lines. To achieve this look, Tesrol has developed the recess rail which is available in either raw MDF, Vacuum Formed or Polyurethane finishes.

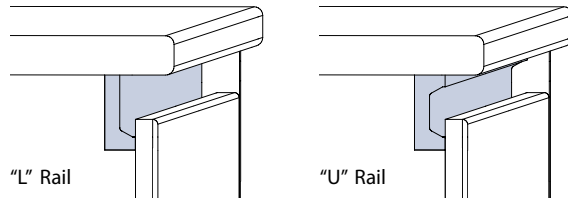

## Vacuum Formed Folded Panels

---

Tesrol was the first company to perfect the development of seamless Vacuum Formed panels, removing the needs for joins thus achieving a seamless paint like finish that is professional and clean.



## Roller Shutters

---

Roller shutters are an excellent way to get access to sliding shelves or appliances without the need for a door to be in the way.

Available in either vacuum formed, painted or raw MDF finishes and in custom sizes, they are a sure way to add functionality and class to your kitchen or cabinets.





## Glass Frames and Glazing Bars

Tesrol offers a range of Glass Frames and Glazing bars to suit your next kitchen or cabinet project.

They help to create a unique spacious showcase while adding a touch of elegance and character to your cabinetry.



## Open Shelves

The use of shelving is a classic yet bold way to showcase and restyle your kitchen. Giving you the ability to showcase your favorite ornamental piece, family memories or whatever your heart desires.

Shelving comes in multiple styles to suit your needs.



## Drawers

Tesrol produces a wide variety of drawer bank to suit your needs based on your preference or style. From individually routed doors to drawers cut from a door and even matching grain doors.

Each option brings a sense of bespoke class to your cabinetry.



## Wine Racks

---

Wine racks are available in a kit form designed for your cabinet maker to directly integrate into your project.

Available in a range of various finishes and designs, it gives a perfect solution for your wine collection.



## Rangehood Canopies

---

Tesrol produces assembled ornate rangehood canopies, allowing your cabinet maker the ability to add some old world charm to your kitchen.

They come available in raw MDF or painted finishes only in either 800mm or 1100mm wide.



## Fretwork

---

Fretwork can be used to adorn your next kitchen or cabinetry project. Tesrol manufacture custom size fretwork in two variations.

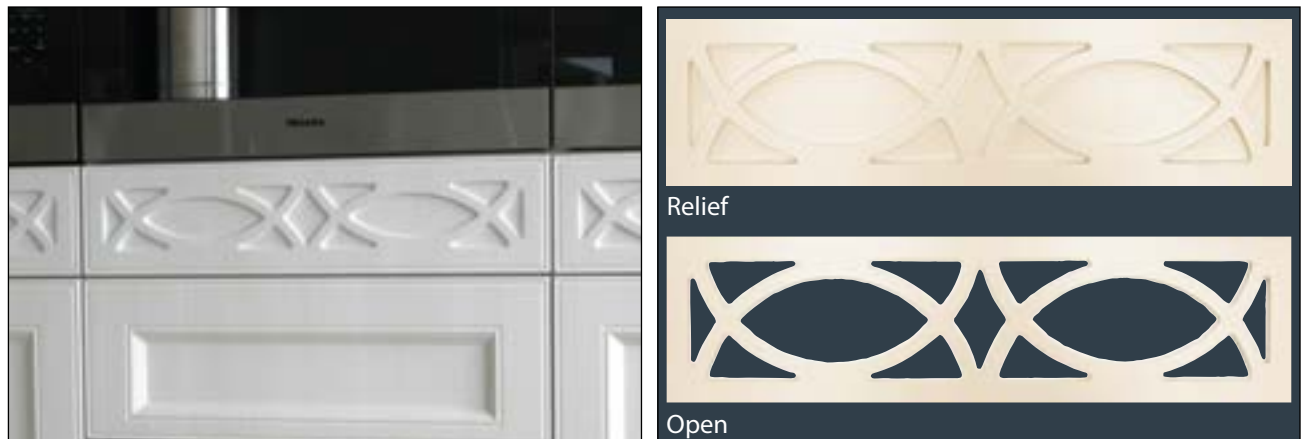

# Capping

Tesrol produces the largest range of pre-finished capping moulding in Australia. Whether your project is modern, traditional or ornate, there is a style designed to suit.

Available in raw MDF, Vacuum Formed, and Painted.



Federation

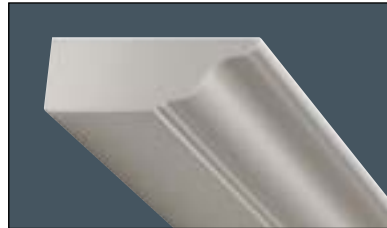

Country

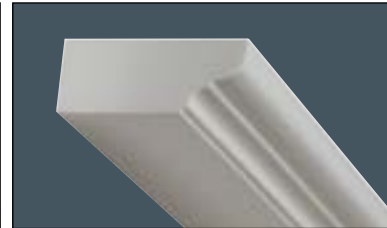

Colonial

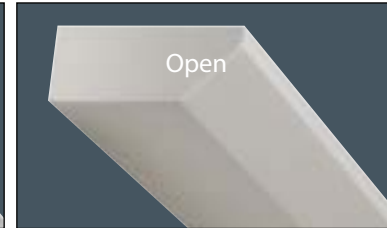

Bevel

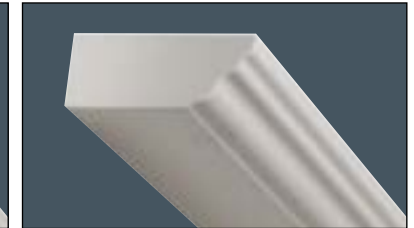

Sculptured



Dental Round

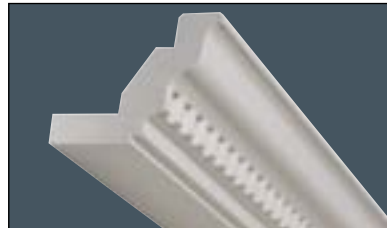

Dental Square \* Not available in Vacuum Formed

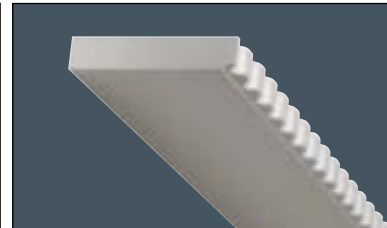

Dental Base

# Decorative Corbels

Corbels can be used to add a professional finishing touch to your cabinetry. Corbels are available in either raw pine or painted finish.

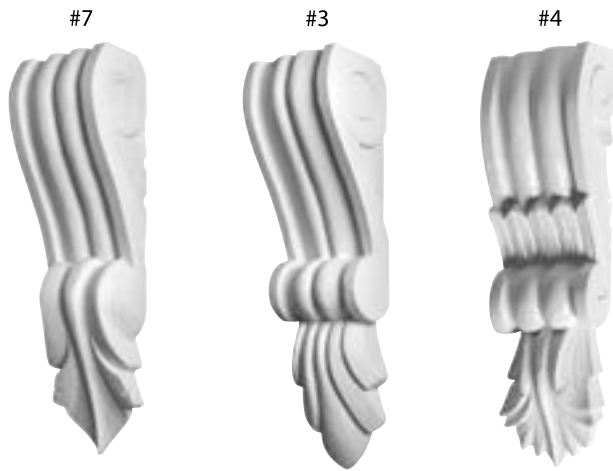
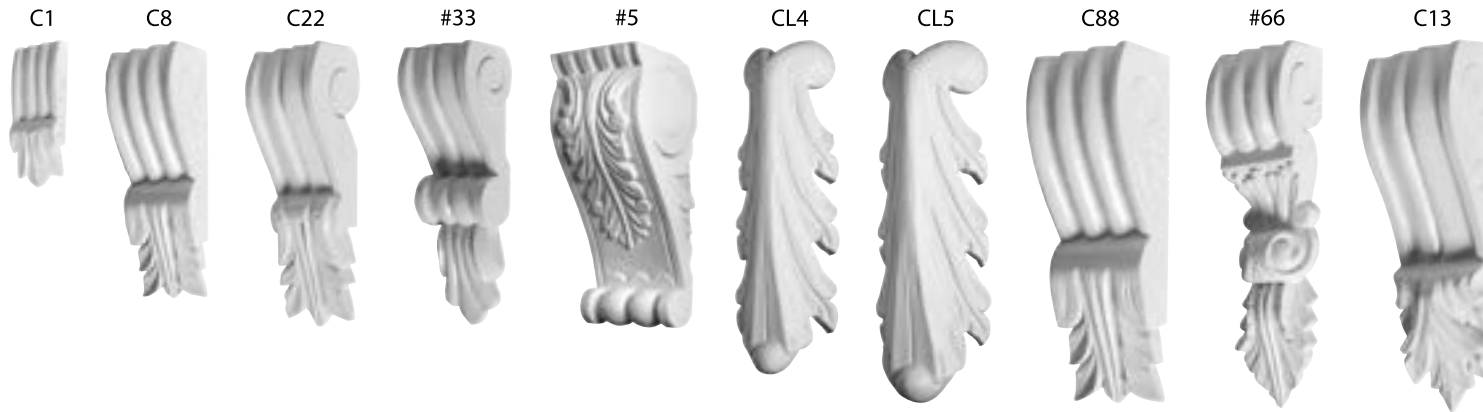

CORBEL SIZES			
Corbels are handcarved and will vary slightly in size			
DESIGN	H x W x D (mm)	DESIGN	H x W x D (mm)
C1	115 x 42 x 19	#66	290 x 70 x 70
C8	195 x 70 x 65	C13	300 x 90 x 85
C22	225 x 70 x 65	#7	335 x 90 x 90
#33	225 x 70 x 65	#3	340 x 90 x 90
#5	230 x 90 x 90	#4	340 x 90 x 65
CL4	265 x 65 x 65	S1	70 x 70 x 19
CL5	285 x 70 x 70	T2 (X2)	115 x 115 x 19
C88	285 x 90 x 85		

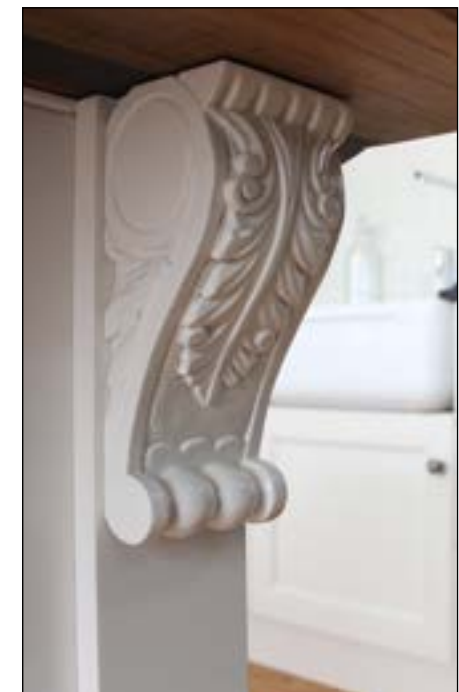

## Decorative Columns and Blocks

Decorative blocks and columns are the perfect accessories for adding a touch of old-world charm to any cabinetry project. They come available in raw MDF, vacuum formed, and painted finishes.

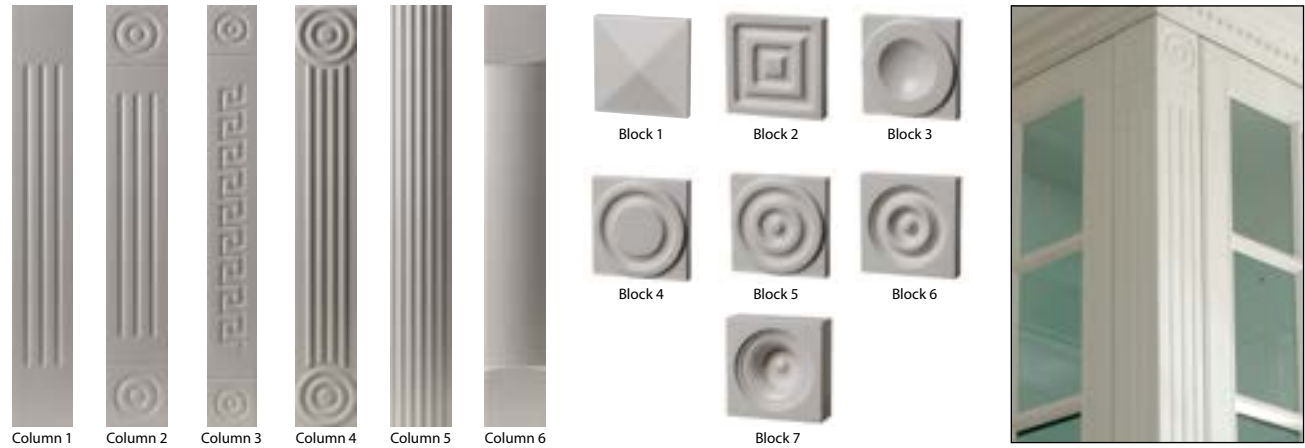

## Skirting

Matching skirting has become a critical component of both kitchen and home design where they can be used to make a project feel more consistent. Tesrol product skirting designs are available in either raw MDF, Vacuum Formed or Painted finishes.



## Heat Deflectors

Some ovens which are flush mounted are not designed to deflect heat away from surrounding surfaces. Tesrol supply heat deflector strips in black, white or chrome, which must be used on Vacuum formed doors. Failure to correctly install heat deflectors may void the product warranty.

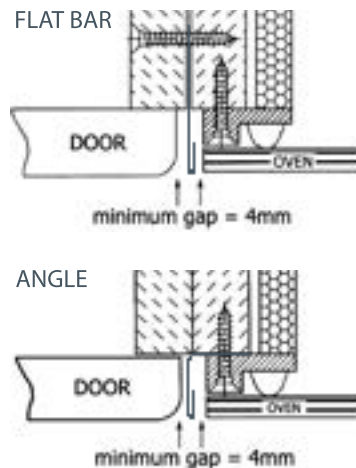

## Maintenance

Caring for your Tesrol products. For more information visit [www.tesrol.com.au](http://www.tesrol.com.au)

Your Tesrol doors and panels can be cleaned using a solution of mild soapy water and a soft cloth. More persistent stains may be treated with methylated spirits followed by soapy water. Never use solvent based or abrasive cleaners which could damage the surface.

Excessive heat can cause damage, so it is important to ensure the following:

- Always use your rangehood when cooking
- Avoid having toasters, coffee machines, etc. in a position where heat is constantly being subjected to the product's surface



Want to find out more?

Join us on social media



[facebook.com/tesrol](https://facebook.com/tesrol)



[instagram.com/tesrol\\_](https://instagram.com/tesrol_)

or visit [www.tesrol.com.au](http://www.tesrol.com.au) for our full design range, product information, gallery, and more.





#### TESROL HEAD OFFICE & SHOWROOM

405 Victoria Street, Wetherill Park, NSW, 2164

#### VICTORIAN OFFICE & SHOWROOM

13/114 Merrindale Drive, Kilsyth, VIC, 3137

#### QUEENSLAND OFFICE & SHOWROOM

3/52 Neumann Rd, Capalaba, QLD, 4157

#### CUSTOMER SERVICE & SALES INQUIRIES

T: (02) 8787 0900

F: (02) 9604 5052

E: [sales@tesrol.com.au](mailto:sales@tesrol.com.au)

#### THE TESROL GUARANTEE

Our commitment to excellence is absolute. Tesrol has been crafting the highest quality cabinet doors for more than 35 years and has become a brand leader and the natural choice of cabinetmakers and interior designers.

All Tesrol products are subject to a rigorous quality inspection process, ensuring that every item supplied meets our high standard. Call Tesrol for further information or for the location of the nearest showroom.

All photographs, graphics and information found in Tesrol print and electronic media are the sole property of Tesrol Joinery Pty Ltd (or its customers when supplied by permission for use in said publication) and cannot be reproduced or copied for any other purpose in any form without written permission from Tesrol Joinery Pty Ltd.

Due to the limitations of the printing process colours indicated on images and graphics are representative only and customers need to select colours from actual product samples.

Copyright Tesrol Joinery Pty Ltd 2022

#### DISCLAIMER

Tesrol expressly disclaim any representations or warranties of any kind, whether express or implied, as to the accuracy, currency, completeness and/or the merchantability or fitness for a particular purpose of any information contained in or provided via this documentation and/or any service or product described or promoted in this document.

It is the customer's responsibility to have all products thoroughly examined by a qualified person, to determine whether they are suitable for the application that they are to be purchased for.

The receiver of our products is fully responsible to check and to take into account possible third party's patent rights, as well as the existing laws in the country of installation prior to installing our product.

No liability may be derived from these images or statements nor from our free technical advice.

Tesrol reserve the right to change, add or remove colours or product without notice.

Version: 2022-1



[www.tesrol.com.au](http://www.tesrol.com.au)